

22049

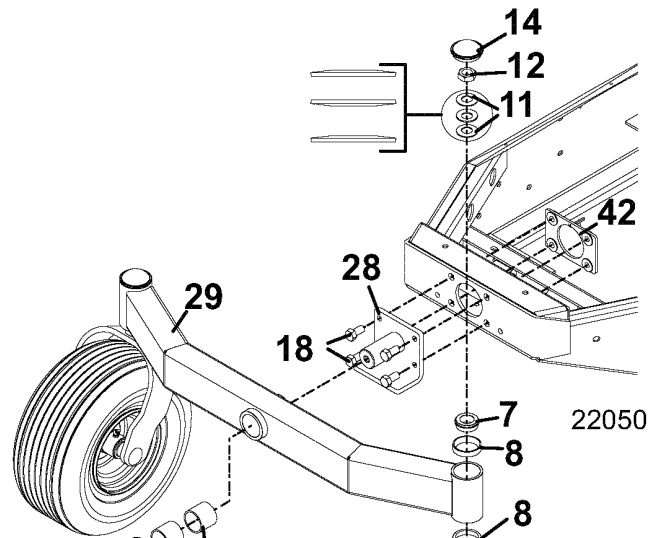

22050

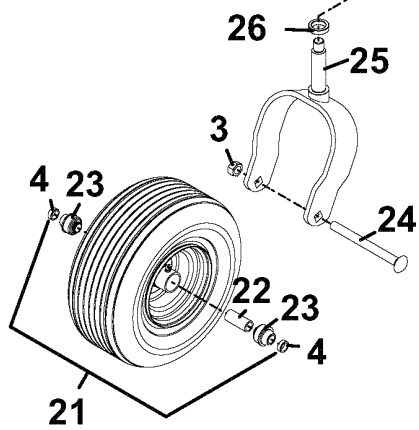
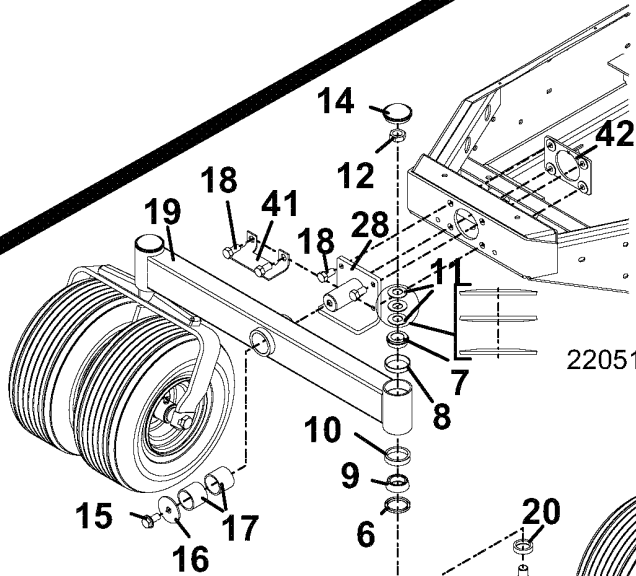
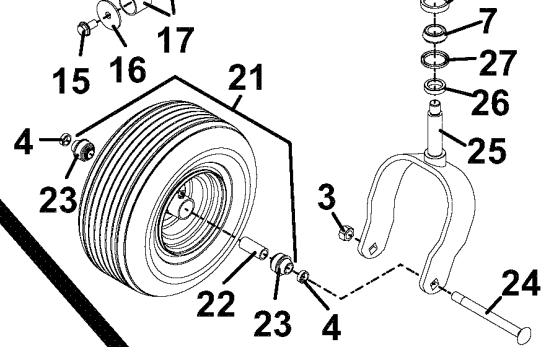

22051

